

Pantry kit:
400/400 cabinet

HØLTE



PANTRY KIT: 400/400 CABINET

Using the HØLTE pantry kit and carefully amended IKEA cabinets, it is possible to create a bespoke pantry cabinet with open shelves and integrated LED lighting. Follow these simple steps to see how.

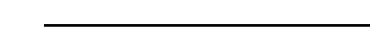



Cut pieces A1 & A2 from
cabinet side 782mm

Cut pieces B1 & B2 from
cabinet side 764mm

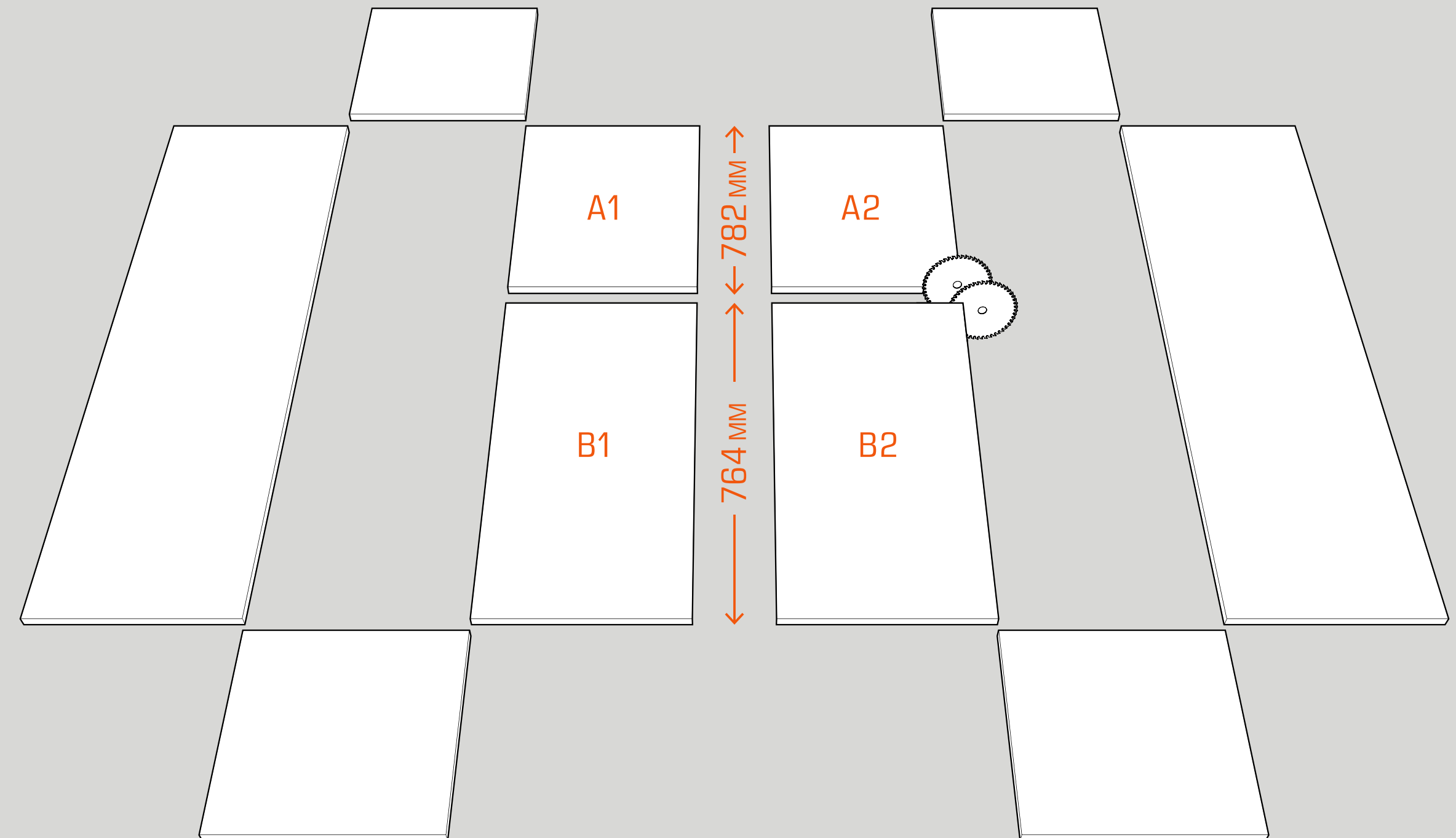

02

Build the two cabinets with cut down side panels as per IKEA instructions

To do this the back boards will also need to be cut to size

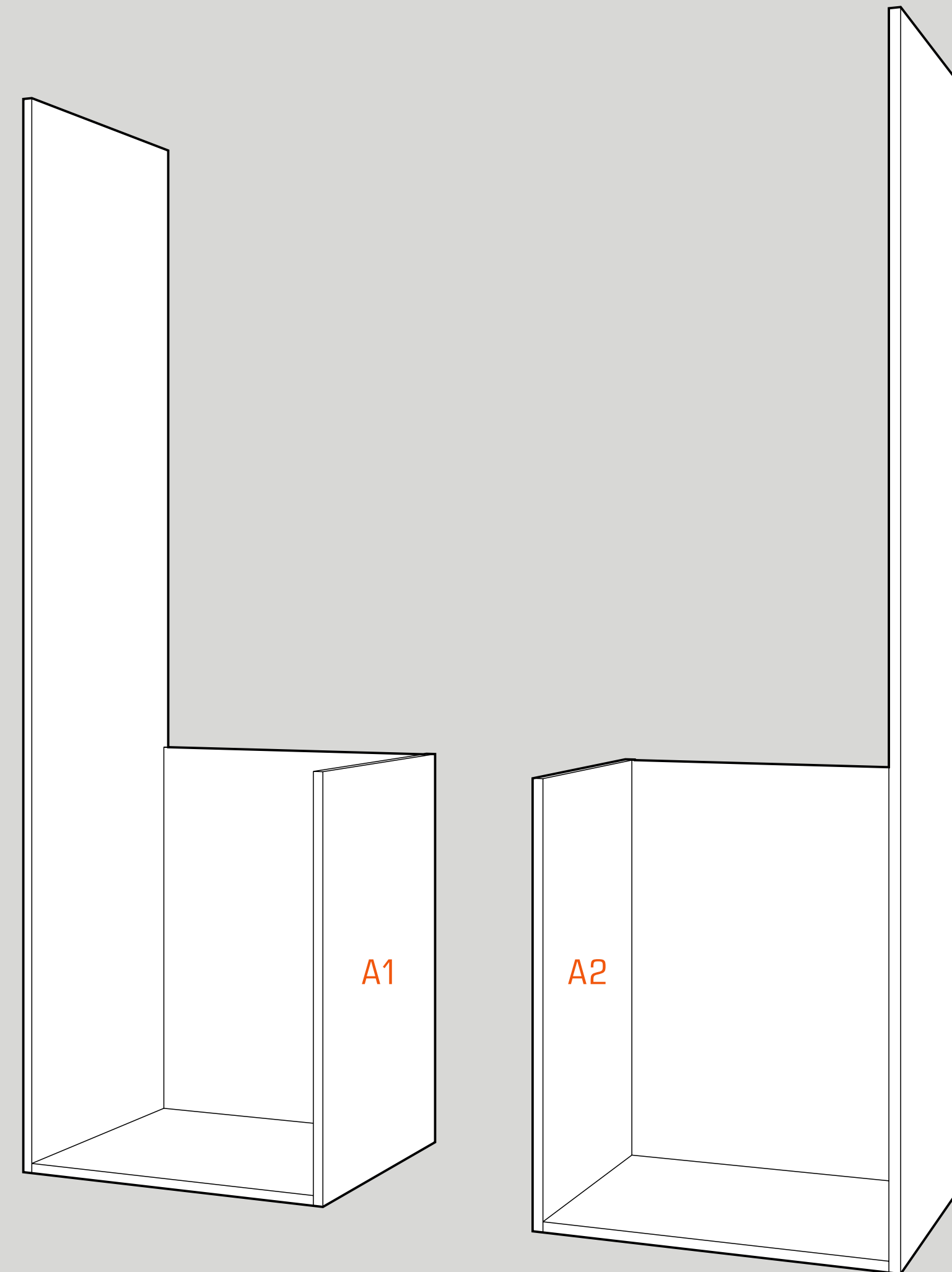

03

Clamp and screw the two cabinets together

Use panels B1 & B2 to create the cabinet top and dividing panel

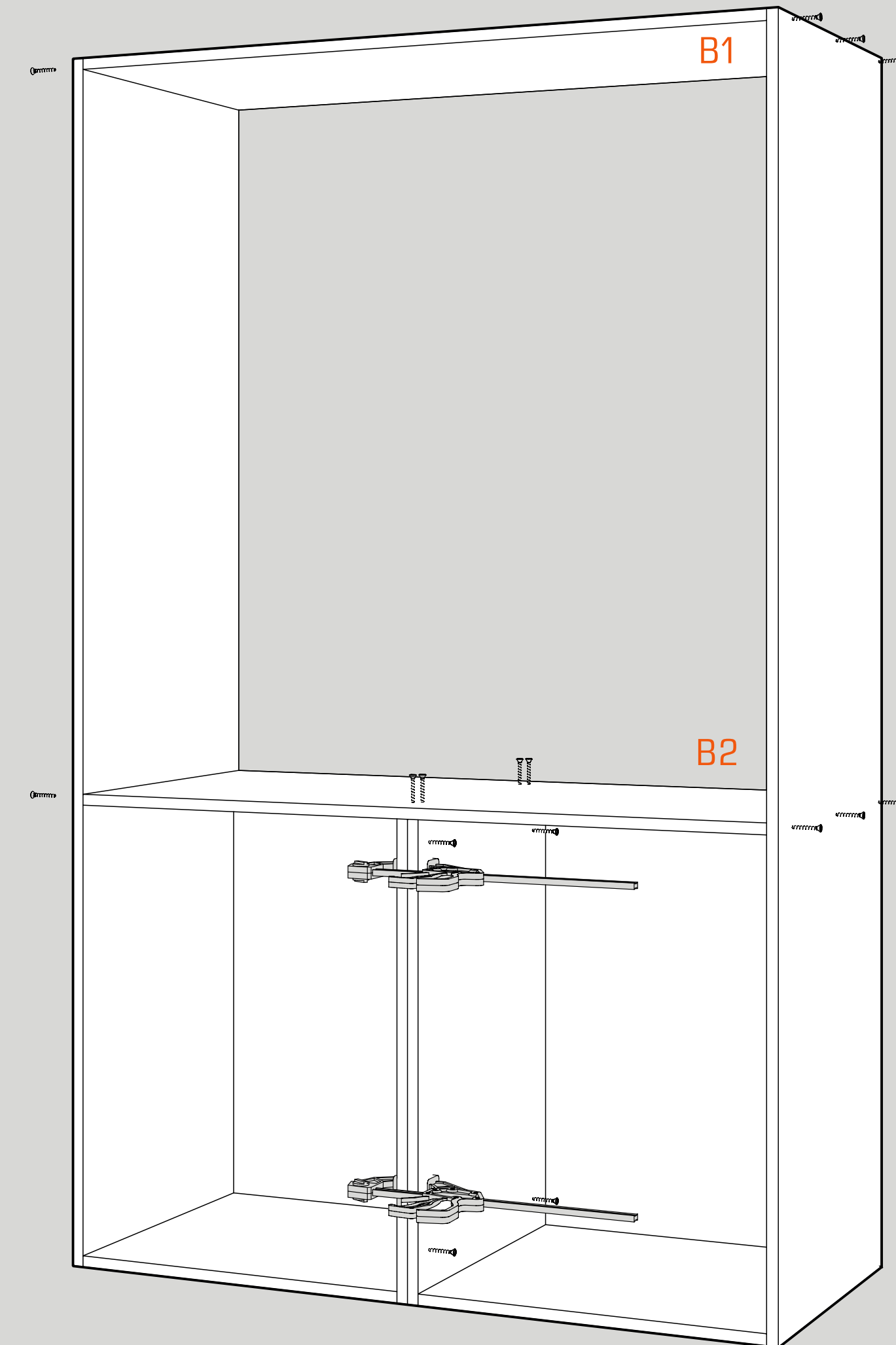

04

Fix 2'x 2' (50 x 50mm)
timber battens flush with
back edge of cabinets

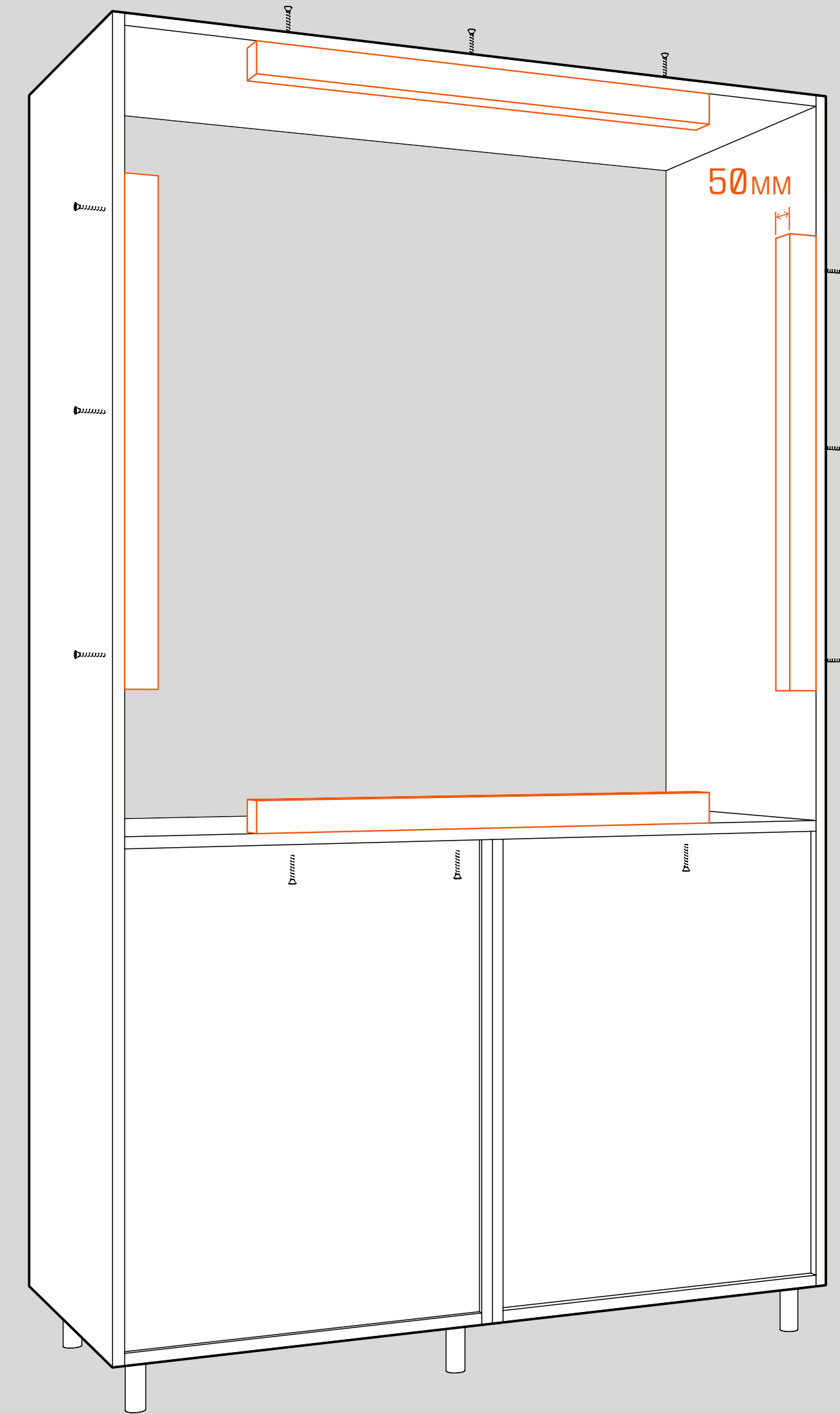

05

Place cabinet in
place, level and fix

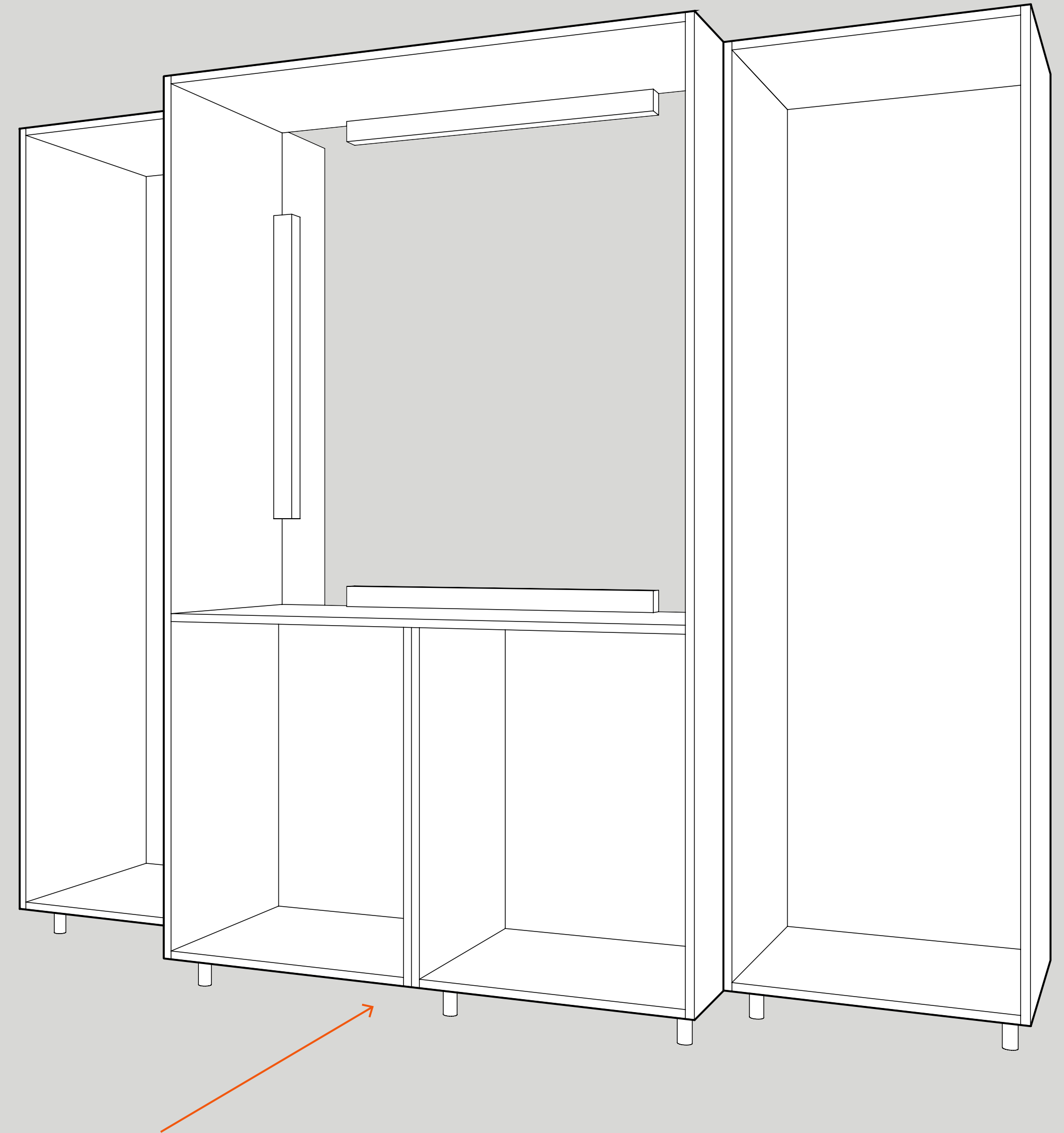

06

Apply grab adhesive
to the front face of the
timber battens

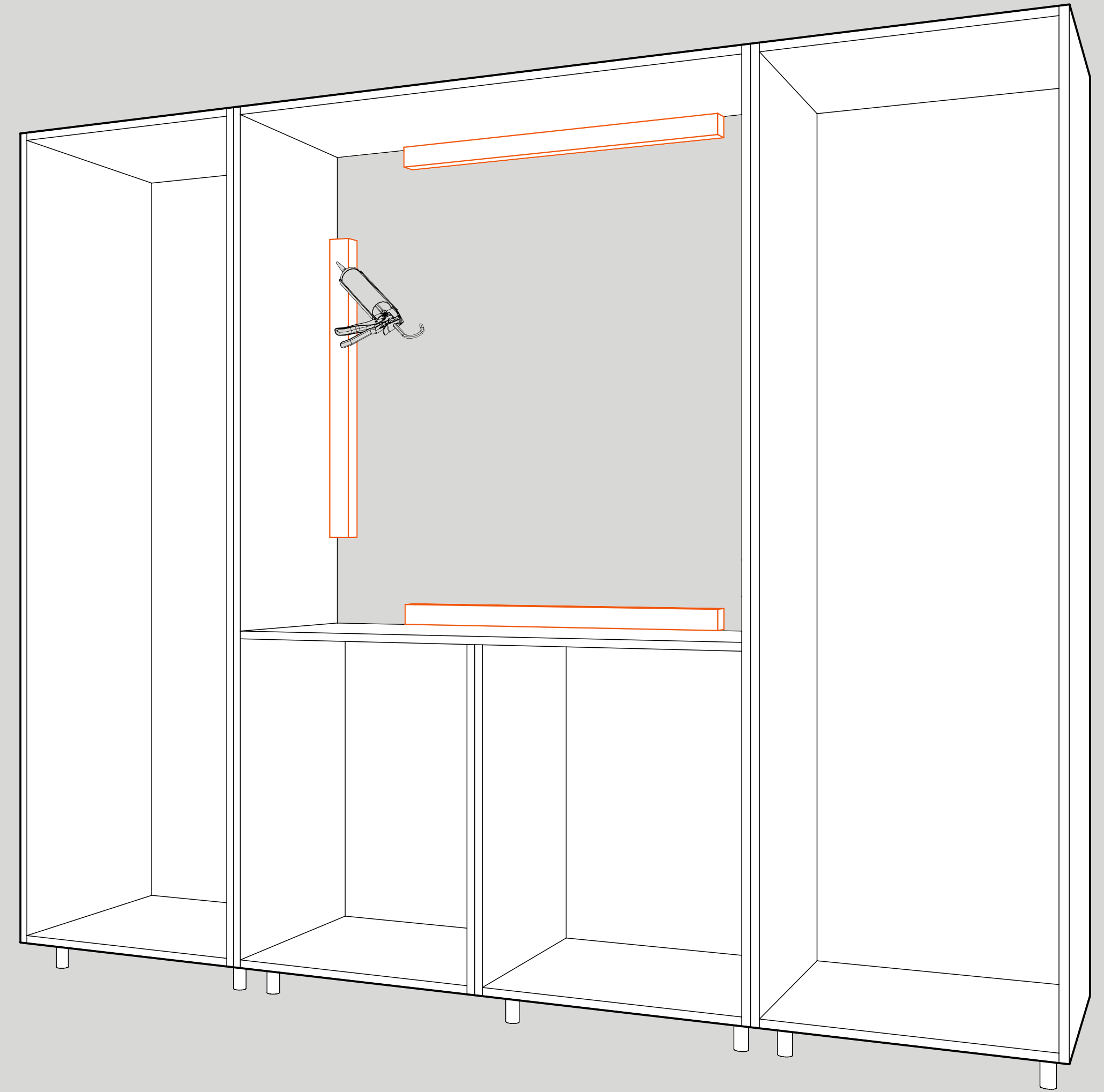

07

Push HØLTE back board
into place & pull through
electric feed

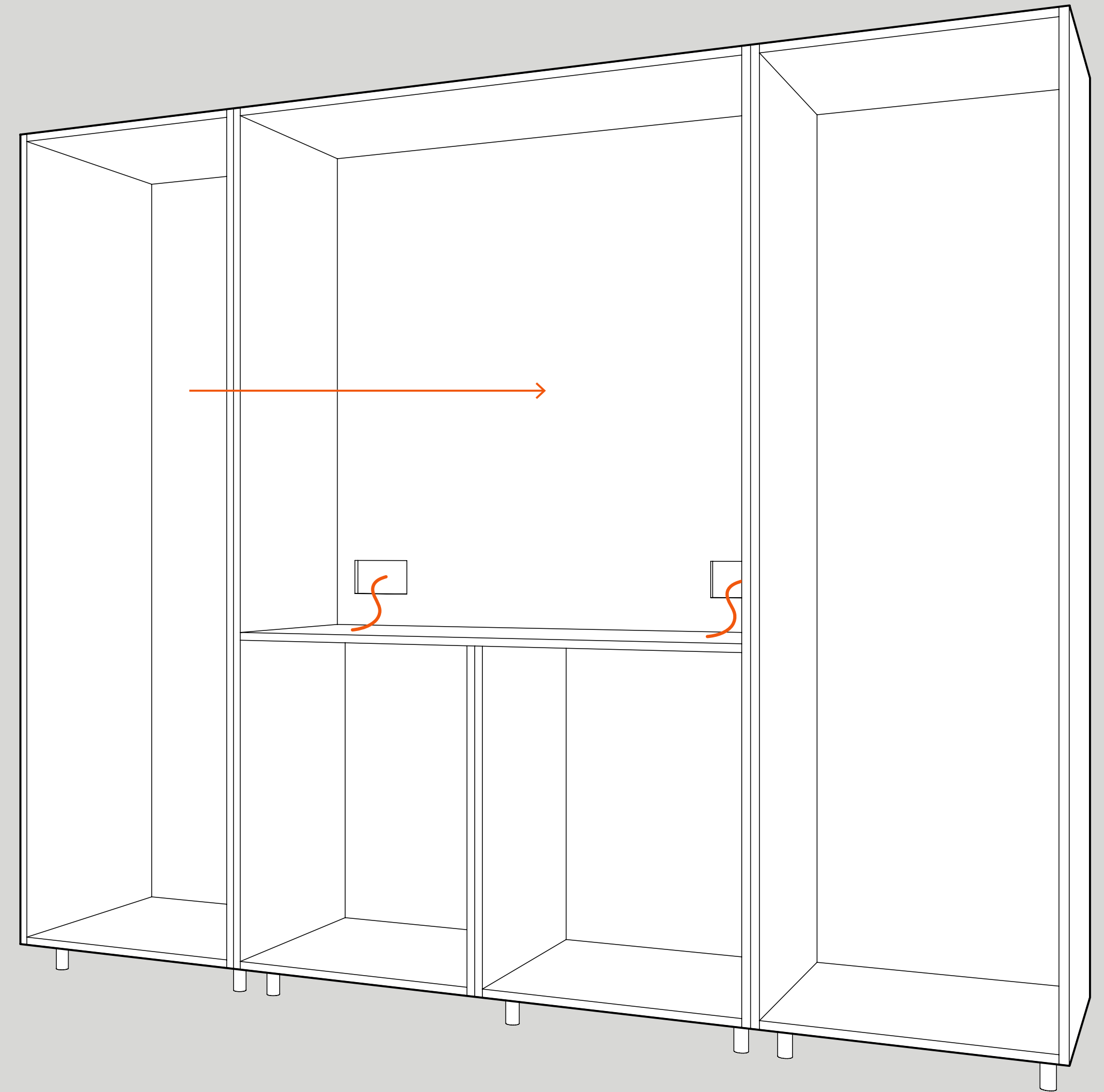

08

Drill holes in top of cabinet to allow cable feed for lighting sensor and LED tape supply

Fix HØLTE lighting panel in place set back 80mm from front edge

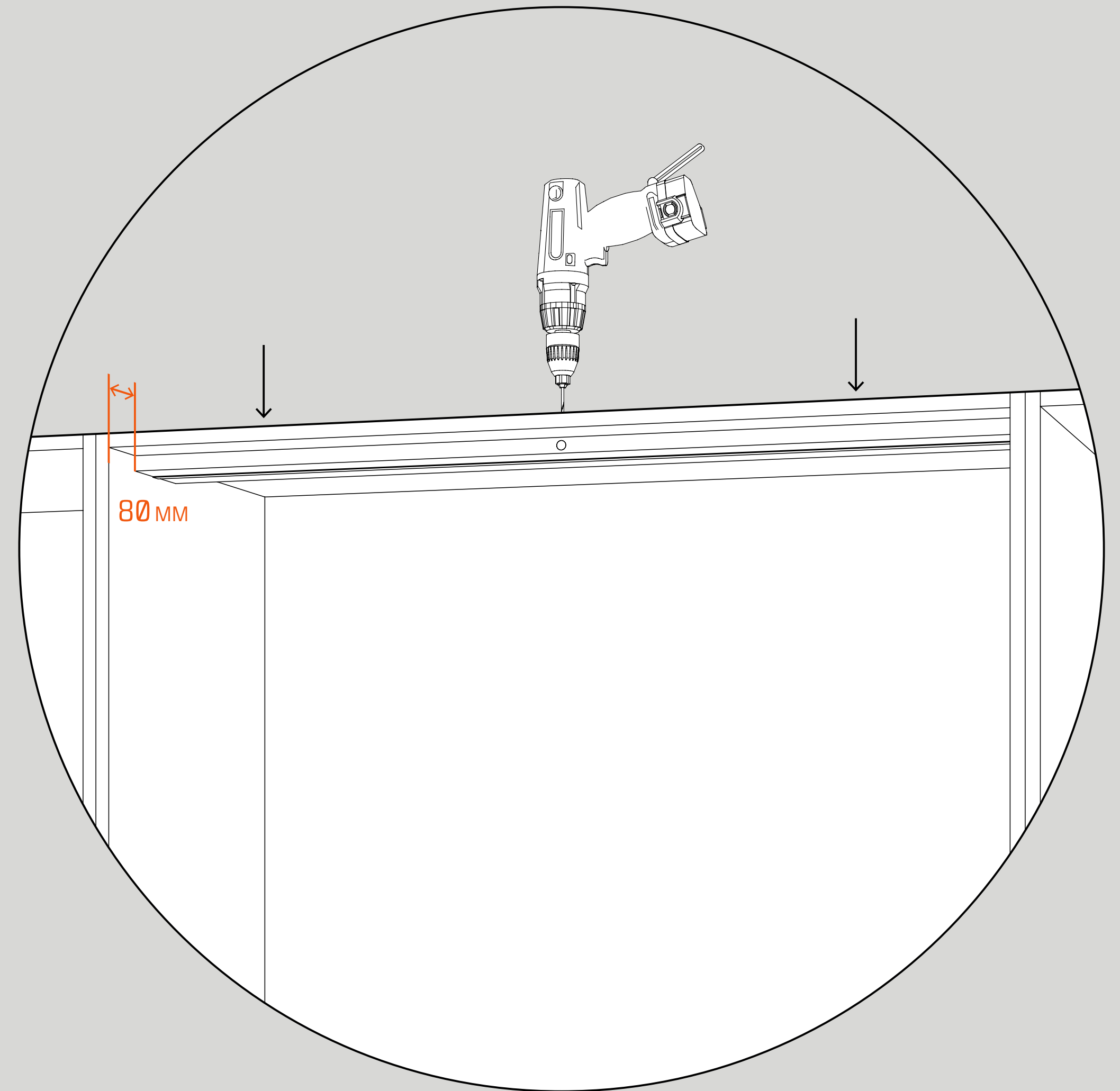

09

Install shelves
and socket plates

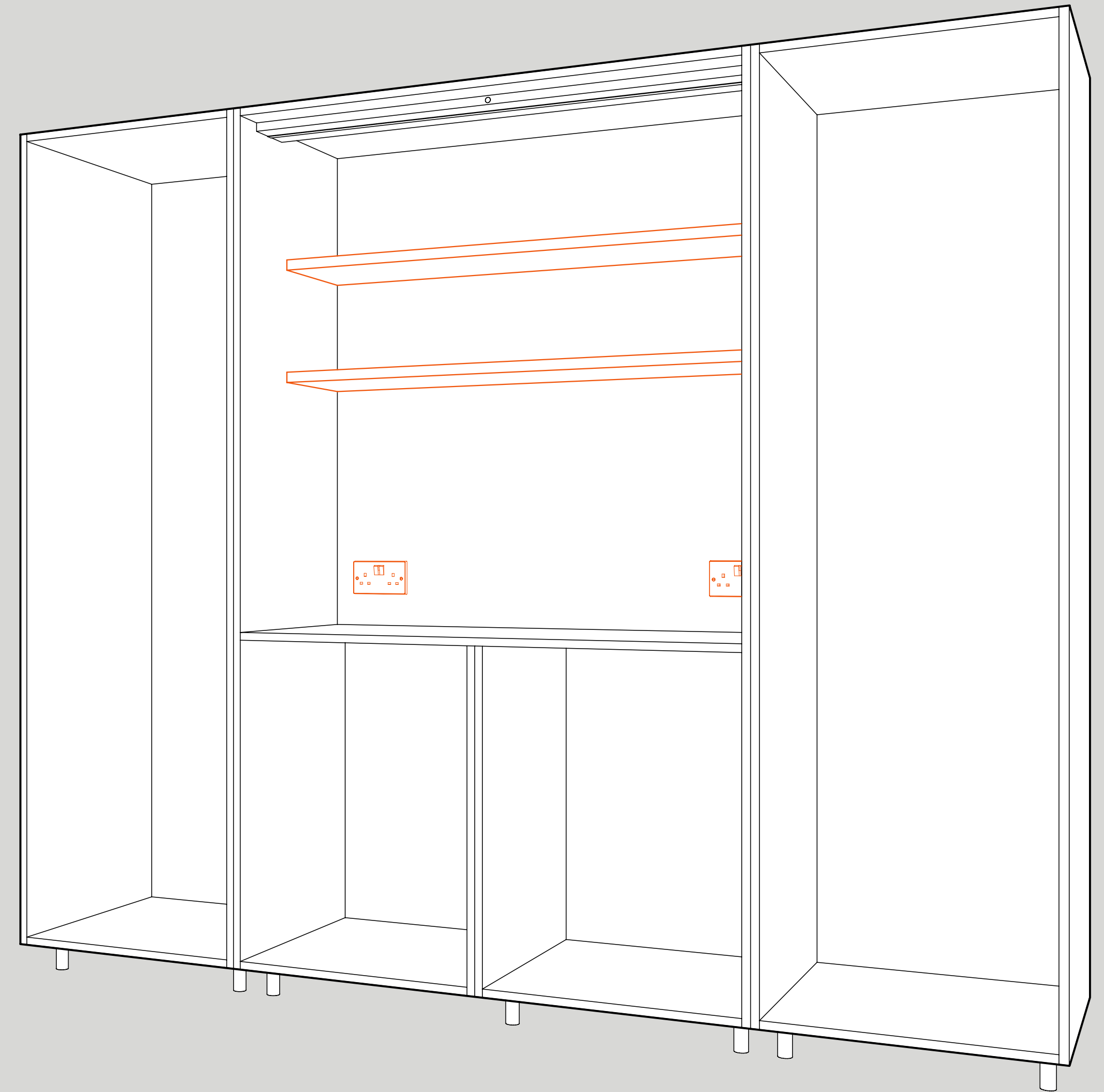

STUDIO
07960 976 895
0207 041 6015

hello@holte.studio

Unit G05 Northside Studios
16-29 Andrews Road
London E8 4QF

Monday to Friday 9am-6pm
Saturday 10am-5pm

holte.studio

HØLTE