

Pantry kit:  
600/600 cabinet

HØLTE



PANTRY KIT: 600/600 CABINET

Using the HØLTE pantry kit and carefully amended IKEA cabinets, it is possible to create a bespoke pantry cabinet with open shelves and integrated LED lighting. Follow these simple steps to see how.

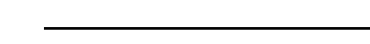



Cut pieces A1 & A2 from  
cabinet side 782mm

Cut pieces B1 & B2 from  
cabinet side 1164mm

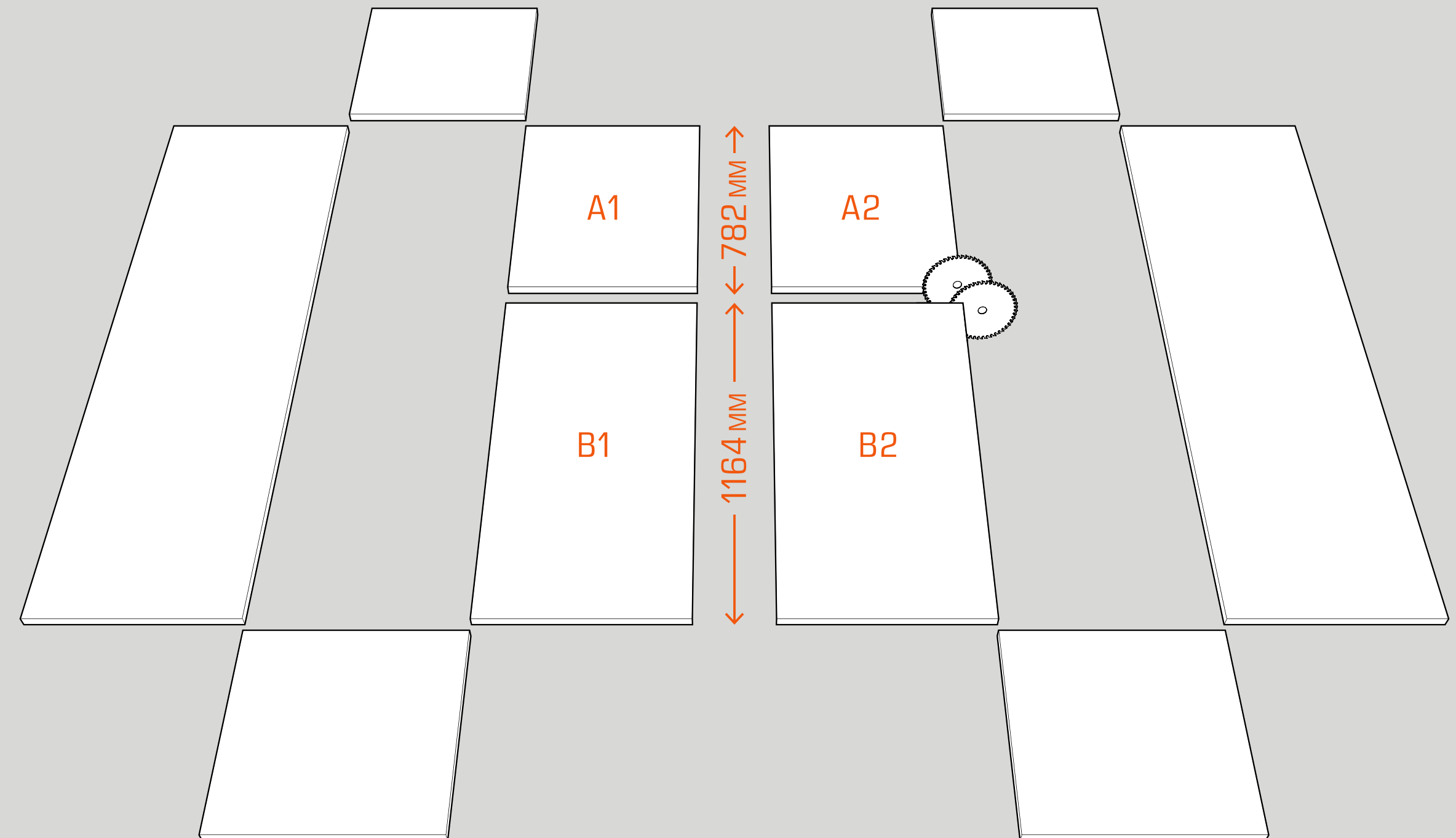

02

Build the two cabinets with cut down side panels as per IKEA instructions

To do this the back boards will also need to be cut to size

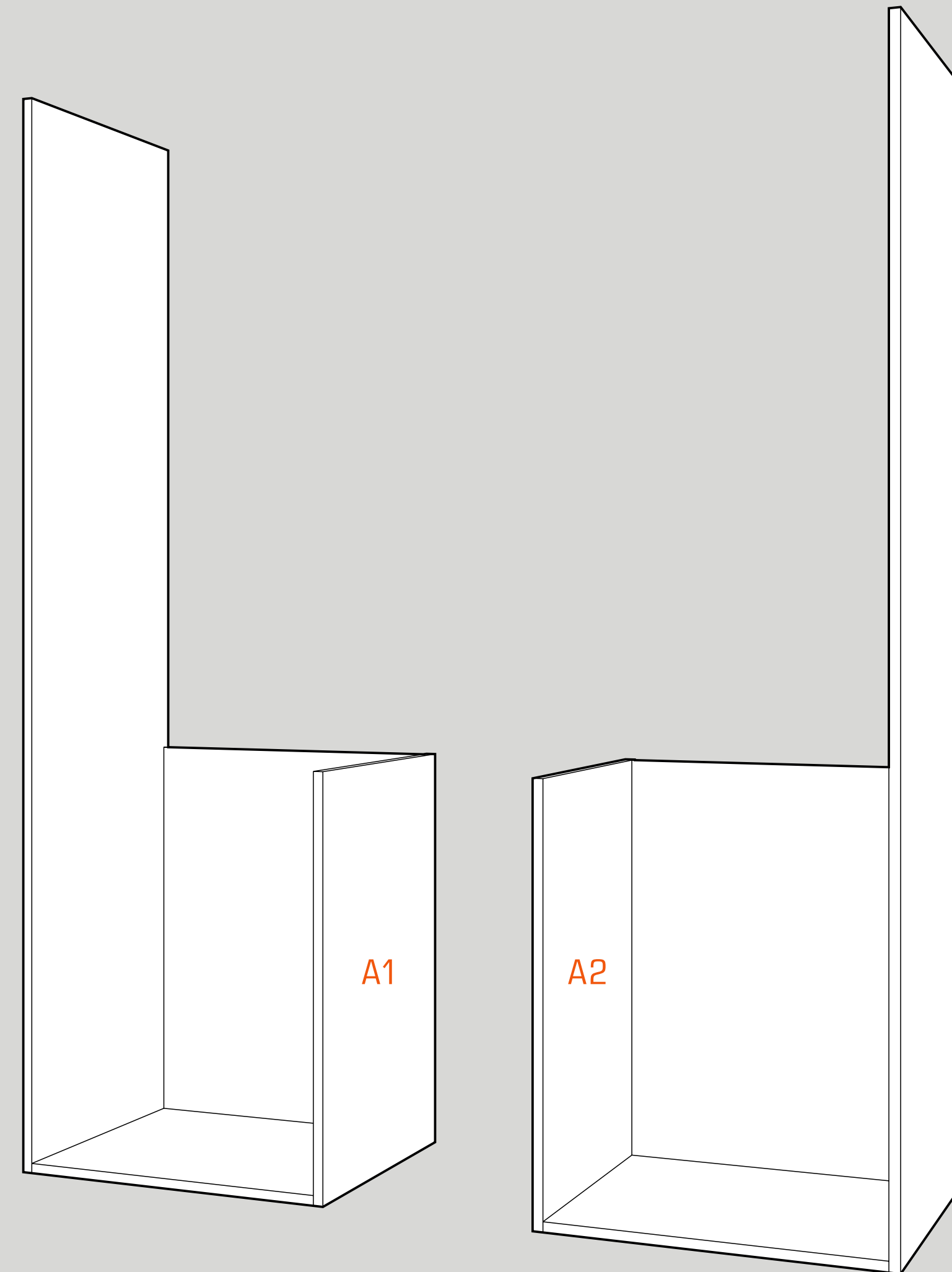

03

Clamp and screw the two cabinets together

Use panels B1 & B2 to create the cabinet top and dividing panel

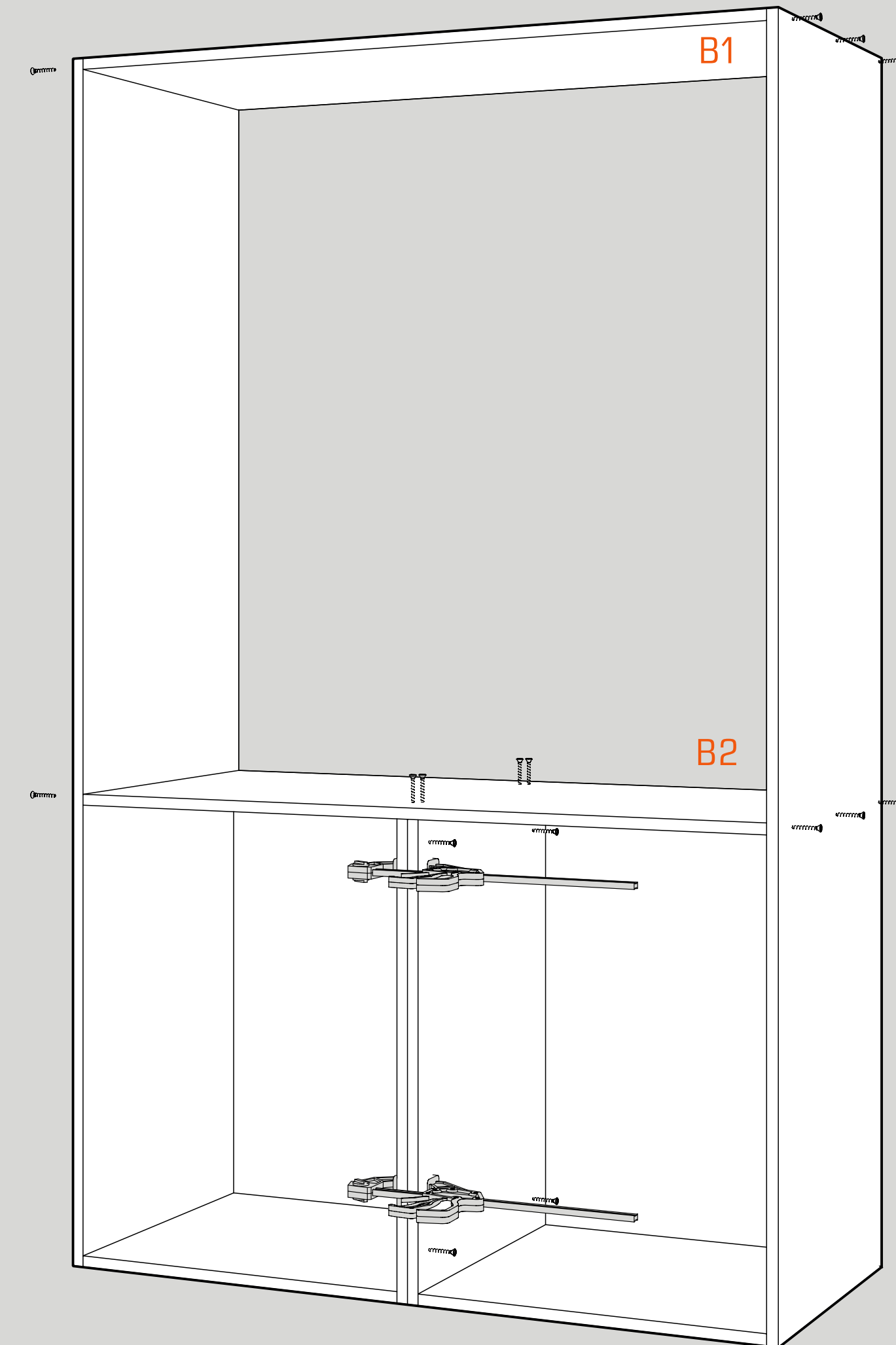

Ø4

Fix 2'x 2' (50 x 50mm)  
timber battens flush with  
back edge of cabinets

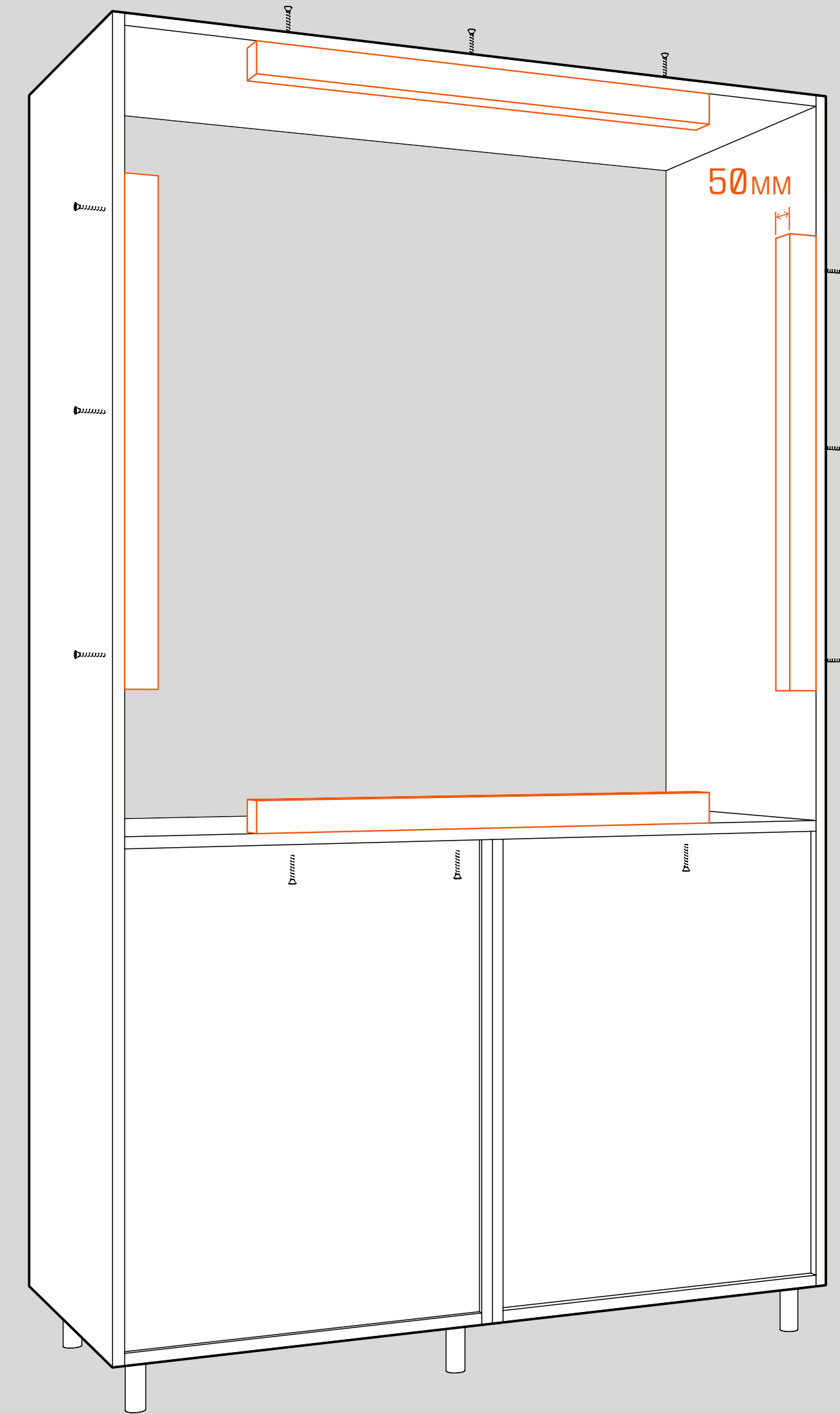

05

Place cabinet in  
place, level and fix

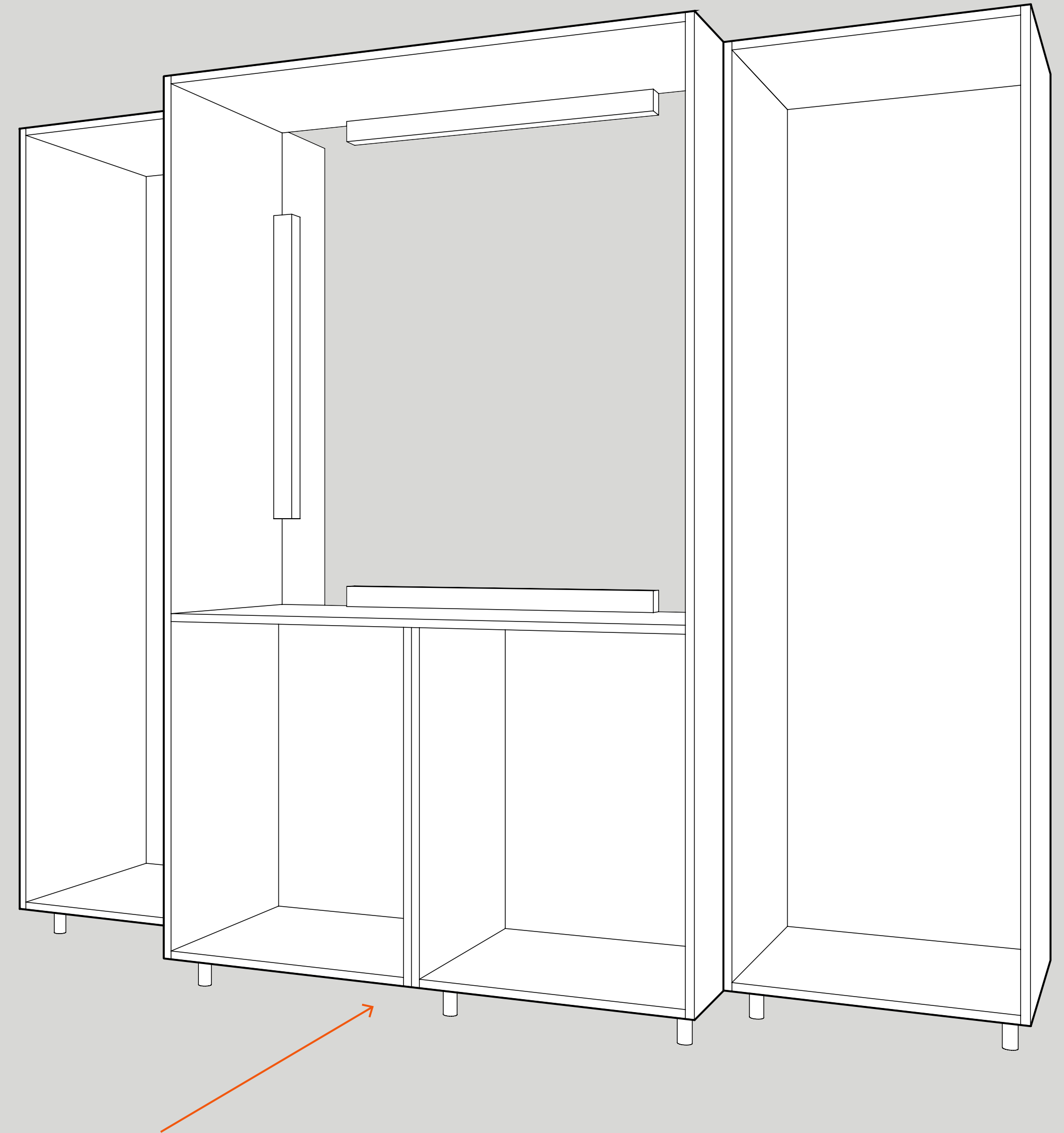

06

Apply grab adhesive  
to the front face of the  
timber battens

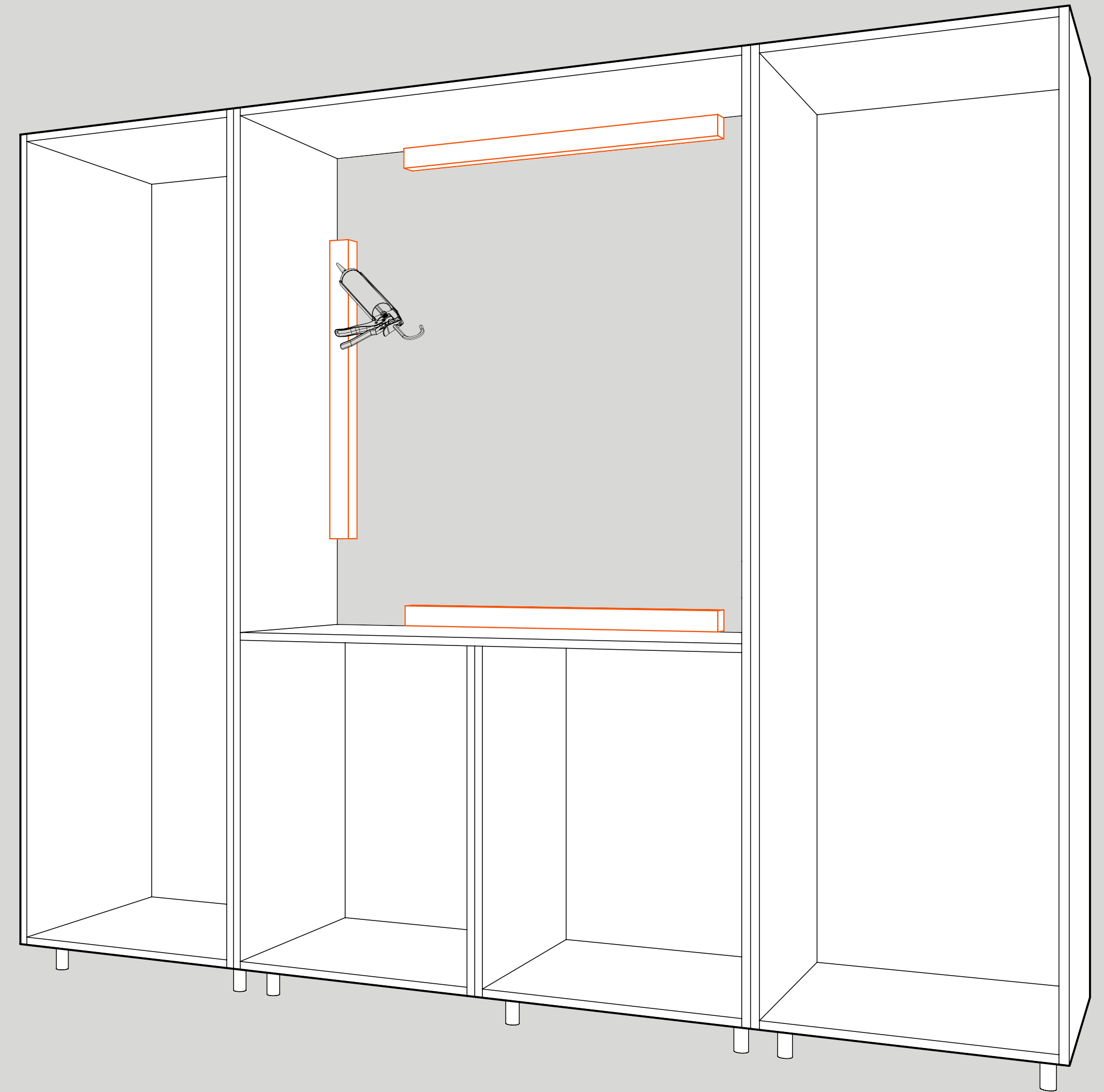



07

Push HØLTE back board into place & pull through electric feed

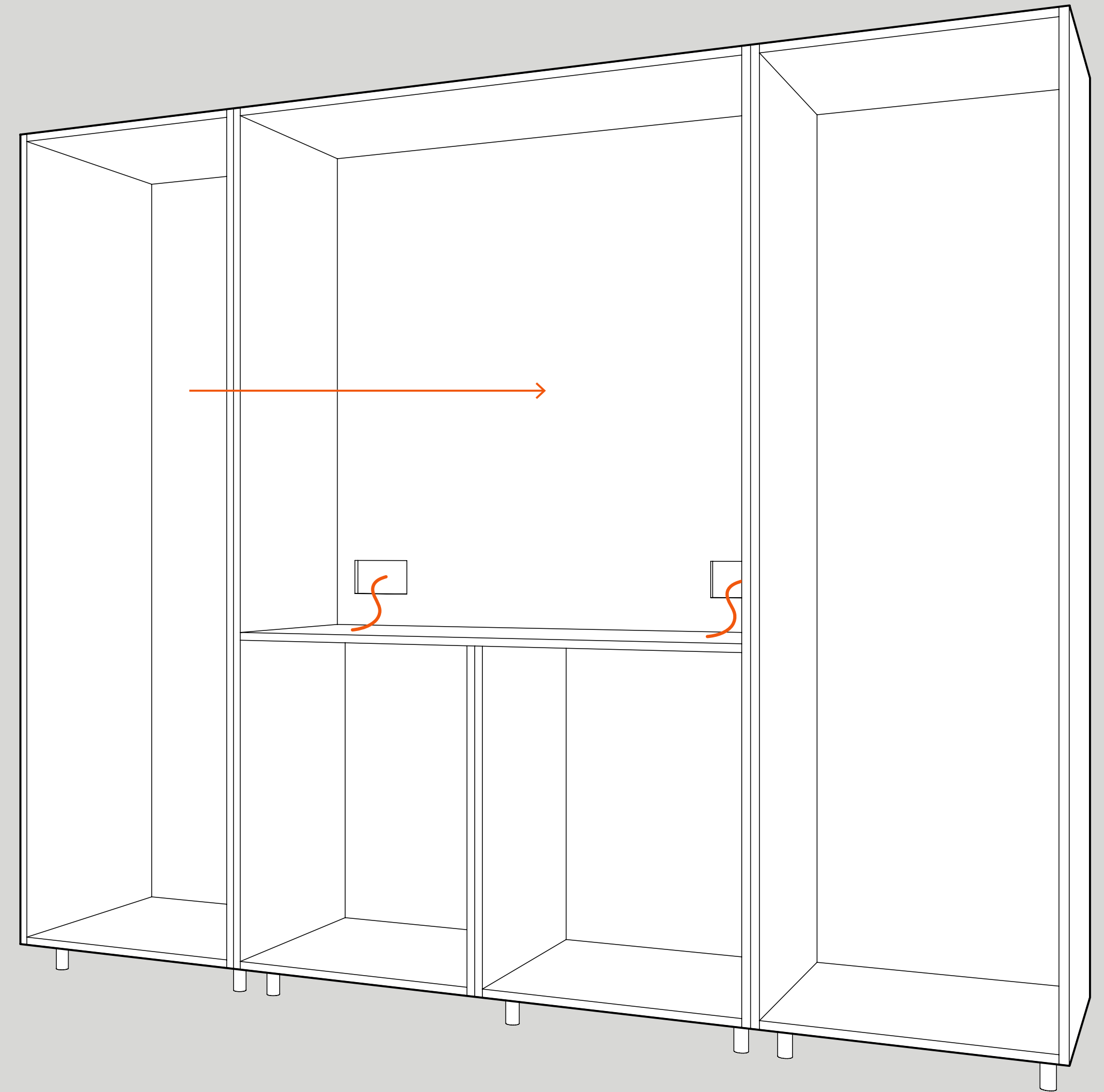

08

Drill holes in top of cabinet to allow cable feed for lighting sensor and LED tape supply

Fix HØLTE lighting panel in place set back 80mm from front edge

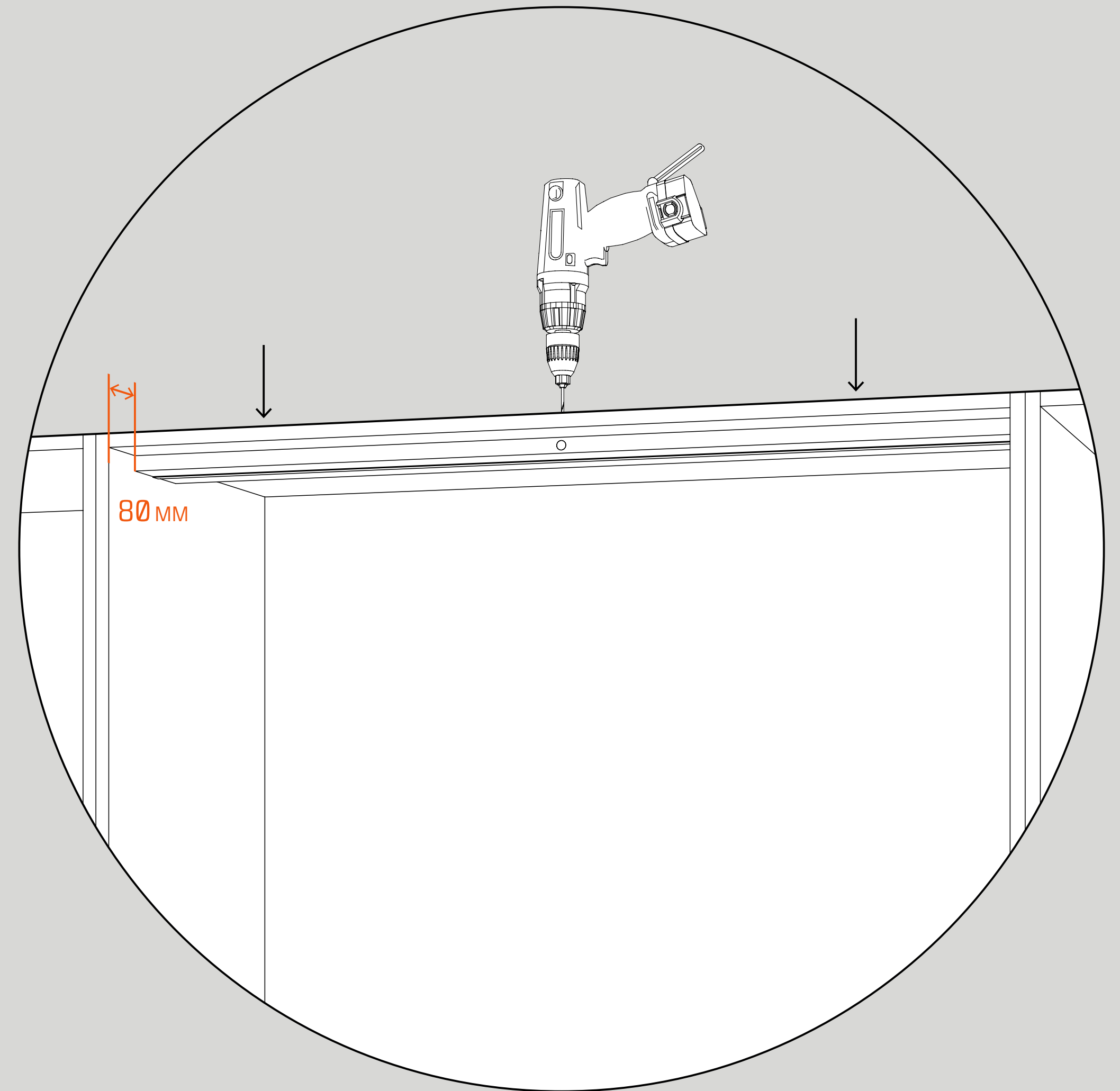

09

Install shelves  
and socket plates

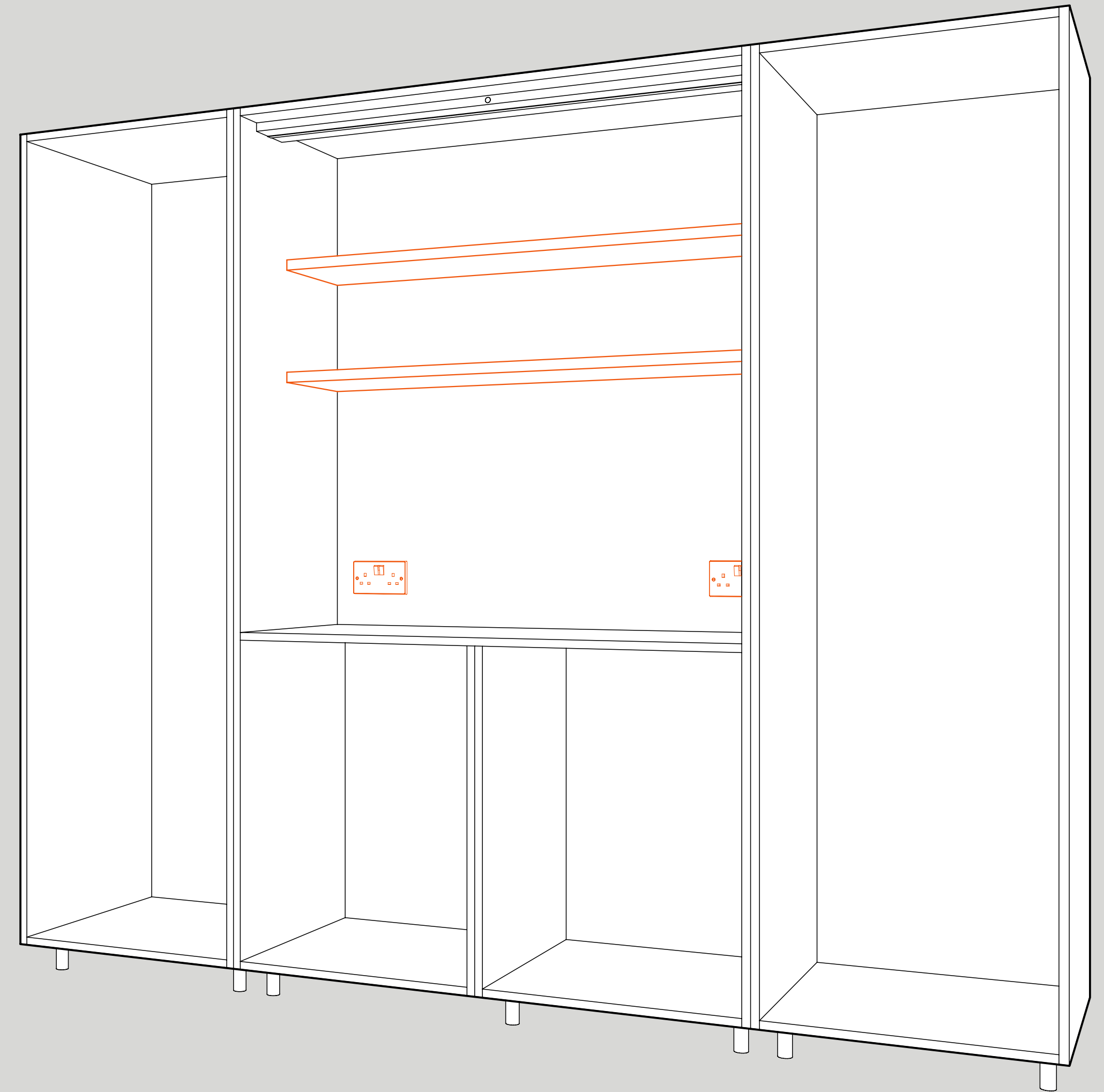

STUDIO  
07960 976 895  
0207 041 6015

[hello@holte.studio](mailto:hello@holte.studio)

Unit G05 Northside Studios  
16-29 Andrews Road  
London E8 4QF

Monday to Friday 9am-6pm  
Saturday 10am-5pm

[holte.studio](http://holte.studio)

**HØLTE**